

AMARR 2731

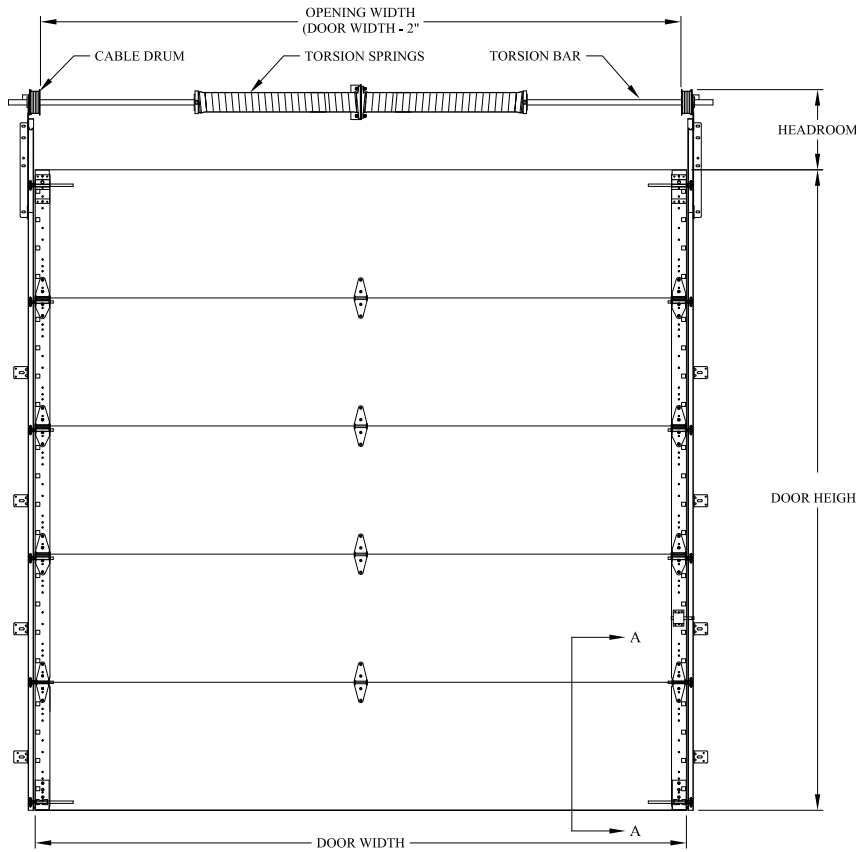

INTERIOR ELEVATION

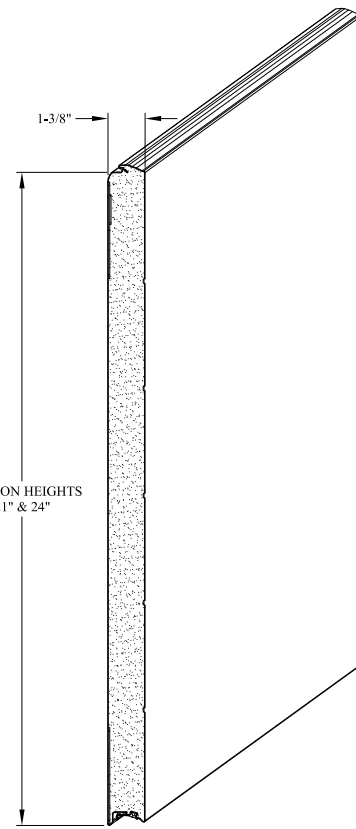

ISOMETRIC PROFILE

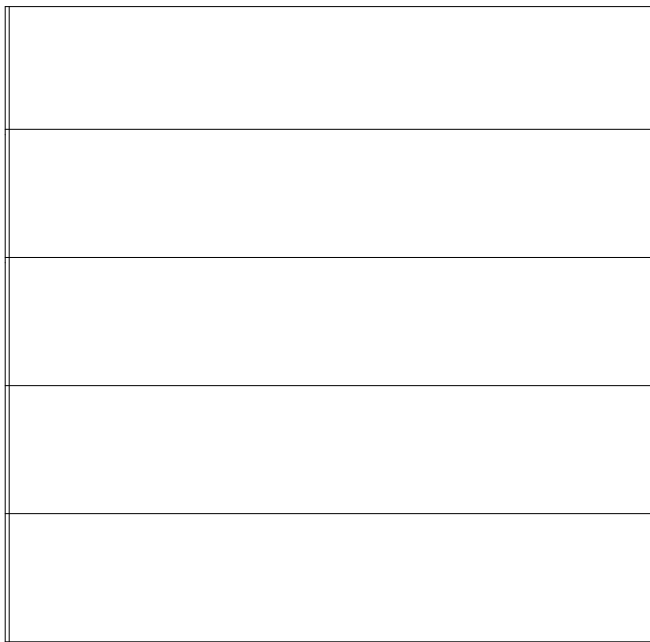

EXTERIOR ELEVATION

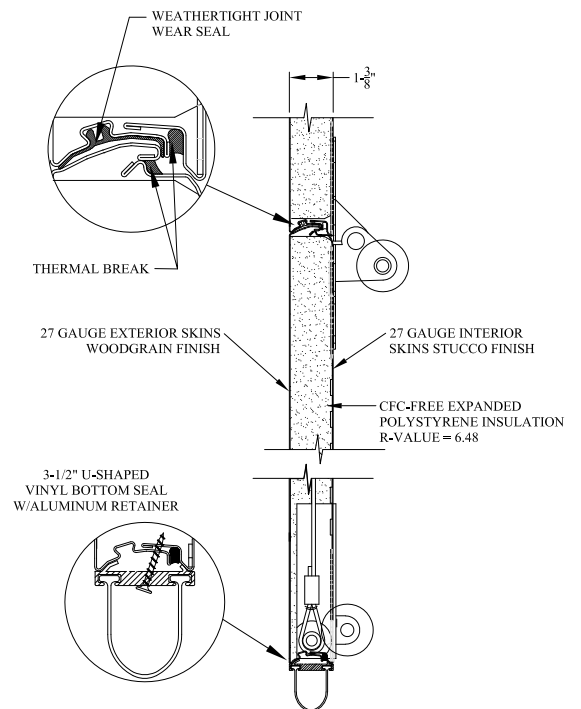

SECTION A-A

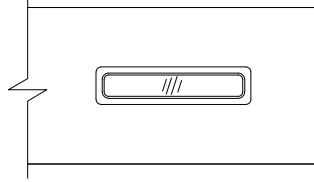

24" X 6 DOUBLE PANE INSULATED PLEXI-GLASS

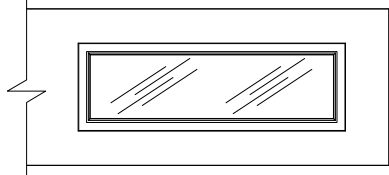

RESIDENTIAL LONG PANEL WINDOW W/ 1/8" CLEAR AND OBSCURE GLASS AND INSULATED CLEAR GLASS

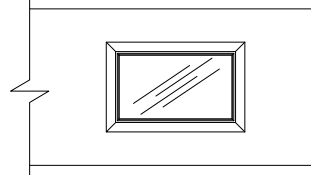

RESIDENTIAL SHORT PANEL WINDOW W/ 1/8" CLEAR AND OBSCURE GLASS AND INSULATED CLEAR GLASS

DOOR WIDTH	MAX No. WINDOWS
8'2"	2
9'2"	2
10'2"	2
11'2"	3
12'2"	3
13'2"	3
14'2"	3
15'2"	4
16'2"	4
18'2"	5

NOTE: CHART ABOVE INDICATES MAXIMUM NUMBER OF WINDOWS PER SECTION.

SECTION ARRANGEMENT CHART

Door Height	21" Bottom	21" Intermediate	24" Bottom	24" Intermediate
7'0"	1	3		
7'3"		3	1	
7'6"		2	1	1
7'9"		1	1	2
8'0"				4
8'3"	Not Available			
8'6"	Not Available			
8'9"	1	4		
9'0"		4	1	
9'3"		3	1	1
9'6"		2	1	2
9'9"		1	1	3
10'0"			1	4
10'3"	Not Available			
10'6"	1	5		
10'9"		5	1	
11'0"		4	1	1
11'3"		3	1	2
11'6"		2	1	3
11'9"		1	1	4
12'0"			1	5

DOOR WIDTHS OVER 16'2" WIDE ARE ONLY AVAILABLE UP TO 8' TALL